

PILING EQUIPMENT

DEEP FOUNDATIONS
& GROUND IMPROVEMENT



THE MULTIPURPOSE RIGS

CH

The Comacchio CH range of piling rigs currently includes **6 models of multipurpose machines** (in a weight range from **15 to 70 tons**), that can be configured to cover a wide range of applications, such as **KELLY PILES, CFA, DP** and **Soil Mixing**. The range also includes **2 models of dedicated CFA rigs**, in the weight class of **50 and 86 tons**.



CH RANGE/TECHNOLOGIES		CH 150	CH 300	CH 320	CH 450
	KP (Kelly Piles)	•	•	•	•
	CFA (Continuous Flight Auger)	•	•	•	•
	Quick Conversion	-	-	•	•1
	DP (Displacement Piles)	-	-	•	•1
	SM (Soil Mixing)	-	-	•	•1
	LDTH (Large DTH)	-	-	•	•1
	MP (Micropiles)	-	-	•	•1
CLASS WEIGHT With kelly, rotary & w/o tool		15 TON	30 TON	32 TON	45 TON

NOTES (1) Only in **WPD** (Winch Pull Down) configuration
The **CH rigs** can be offered in different **LHR** (low head room) configurations, designed for the construction of bored piles in challenging access sites

CHF 500	CH 650	CH 850	CHF 900	MULTIPURPOSE PILING RIGS CH	
-	•	•	-	KP (Kelly Piles)	
•	-	•	•	T4 Quick Conversion	CFA (Continuous Flight Auger)
-	•1	•1	-		
-	•1	•1	-	DP (Displacement Piles)	
-	•1	•1	-	SM (Soil Mixing)	
-	•1	•1	-	LDTH (Large DTH)	
-	•1	•1	-	MP (Micropiles)	
50 TON	65 TON	85 TON	86 TON	CLASS WEIGHT With kelly, rotary & w/o tool	

NOTE (1) Only in **WPD** (Winch Pull Down) configuration

EFFICIENCY. HIGH PERFORMANCE. SUSTAINABILITY

CH



 	<p>ENERGY EFFICIENCY & SUSTAINABILITY</p>	<ul style="list-style-type: none"> • Stage V technology (EPA Tier 4 Final) for exhaust aftertreatment and engine control • HPE (High Power Efficiency) system reducing energy dissipation • Optimized engine and hydraulic oil cooling system • Low-noise rotary head • Reduced fuel consumption and lower noise levels
	<p>FLEXIBILITY & HIGH PRODUCTIVITY</p>	<ul style="list-style-type: none"> • Two types of crowd system (cylinder / winch pull-down) • Easy-to-install conversion kits & counterweights • Modular mast design • Multipurpose design of rotary head • Operational flexibility in all piling and soil consolidation techniques
	<p>EASY TRANSPORT & RIG-UP</p>	<ul style="list-style-type: none"> • Compact design • Reduced mobilization costs • Short rig-up/rig-down times • Assisted and automated rig-up functions • Radio control for track functions
 	<p>EASY OPERATION & FLEET MANAGEMENT</p>	<ul style="list-style-type: none"> • Comacchio Controlling System (CCS) • Highly ergonomic cabin design • User-friendly interface ensuring complete interactive control • Assisted and automated drilling functions • ComNect fleet management software
	<p>SAFETY & MAINTENANCE</p>	<ul style="list-style-type: none"> • Designed and manufactured entirely in Italy • Optimal material selection and state of the art high-quality components • Clean uncluttered layout of all components • Tops and Fops-1 certified cabin • Scalable design of the base carriers • Safety features in line with the strictest EU regulations
	<p>LIVE THE EXPERIENCE</p>	

SAFETY. COMFORT. TECHNOLOGY

CH

The concept of the CH range starts from the idea of a consistent development of all models, given by the **modular design of the base carriers**, the **common concept of the hydraulic and electrical systems**, **electronically controlled** through the **CCS software**, and the **cab project**, developed in-house by **Comacchio**.

Inspired by the automotive-style fit and finish, the new **Comacchio cab stands out for its ergonomic design and safety features**, offering **high level of comfort** for the operator and ensuring **smooth and easy operation**.



ENHANCED SAFETY

- **Tops & Fops-1** Certified
- Front & top cab **protective grate**



HIGH VISIBILITY

- Fully glazed with **automatic sliding door**
- **Set of 4 cameras** with in-cab monitor for all-around view
- **LED** work lights

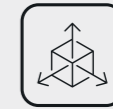

WORKPLACE COMFORT

- Heating and **air conditioning**
- **Radio / CD player, Bluetooth system**, phone **charger**, **refrigerated** bottle-holder
- **Storage** compartments



USER-FRIENDLY INTERACTIVE CONTROL

- **12" color touch screen display** for the **monitoring and control** of the operating parameters **via CCS software**



CCS- COMACCHIO CONTROLLING SYSTEM

- Managing and controlling of all the **electrically actuated functions**
- **Diagnosis check control** and errors display
- **Pump pressures display**
- **Mast verticality control** by means of an electronic inclinometer
- **Drilling depth display**
- Rotary **speed and pressure** display
- **Crowd pressure display**
- **Automatic rotary speed management (ASM)** setting allowing the drilling in constant power mode
- **Interactive rotary multiple gear system (IMGS)**, allowing the operator to manually adjust the gear speed
- **Automatic winches control** on rigging and derigging phases
- **Slewing back to centre hole** with automatic stop
- **Diesel engine interface** on a separate display



SOUND INSULATION

- In-cab **soundproofing**



IMPROVED ERGONOMICS

- **Roomy inner space**
- **Fully adjustable working seat** with **dynamic suspension** system
- Ergonomic arrangement and **design of multifunction controls**

KELLY PILES



CH 150

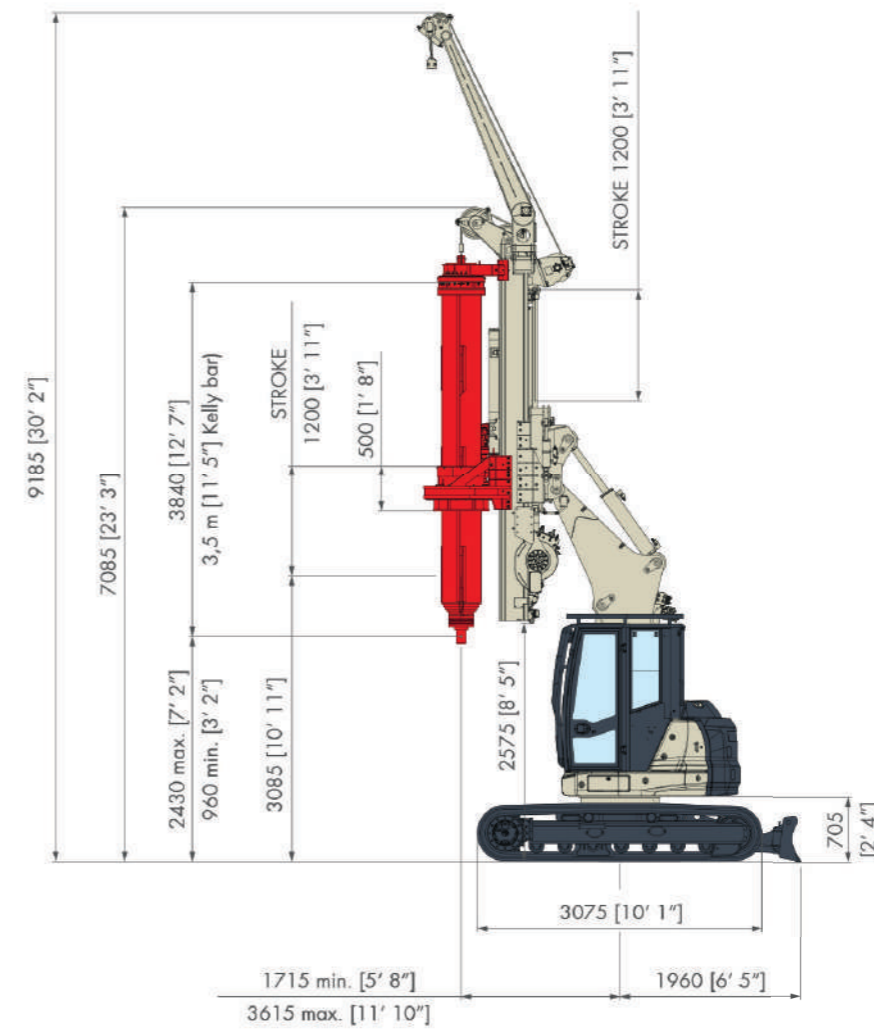

CPD (Cylinder Pull Down)	m.s.	i.s.		
Nominal max. torque	kNm	lbf-ft	44 at 35 MPa	32,450 at 5,076 psi
Max. torque	kNm	lbf-ft	35 at 28 MPa	25,800 at 4,060 psi
Engine power rating	kW	hp	54 at 2100 rpm	73 at 2100 rpm
Max. pile diameter	mm	ft-in	750 - 1.000¹	2' 6" - 3' 3" ¹
Max. pile depth	mm	ft-in	27.000²	88' 7" ²
Operating weight w/o tool	kg	lbs	15.000³	95,000 ³

NOTES	(1) Tool under mast	(3) c/w 7 x 2,7 m (7 x 8'10") long Kelly bar
	(2) Using 9 elements locking kelly bar	

CH 300

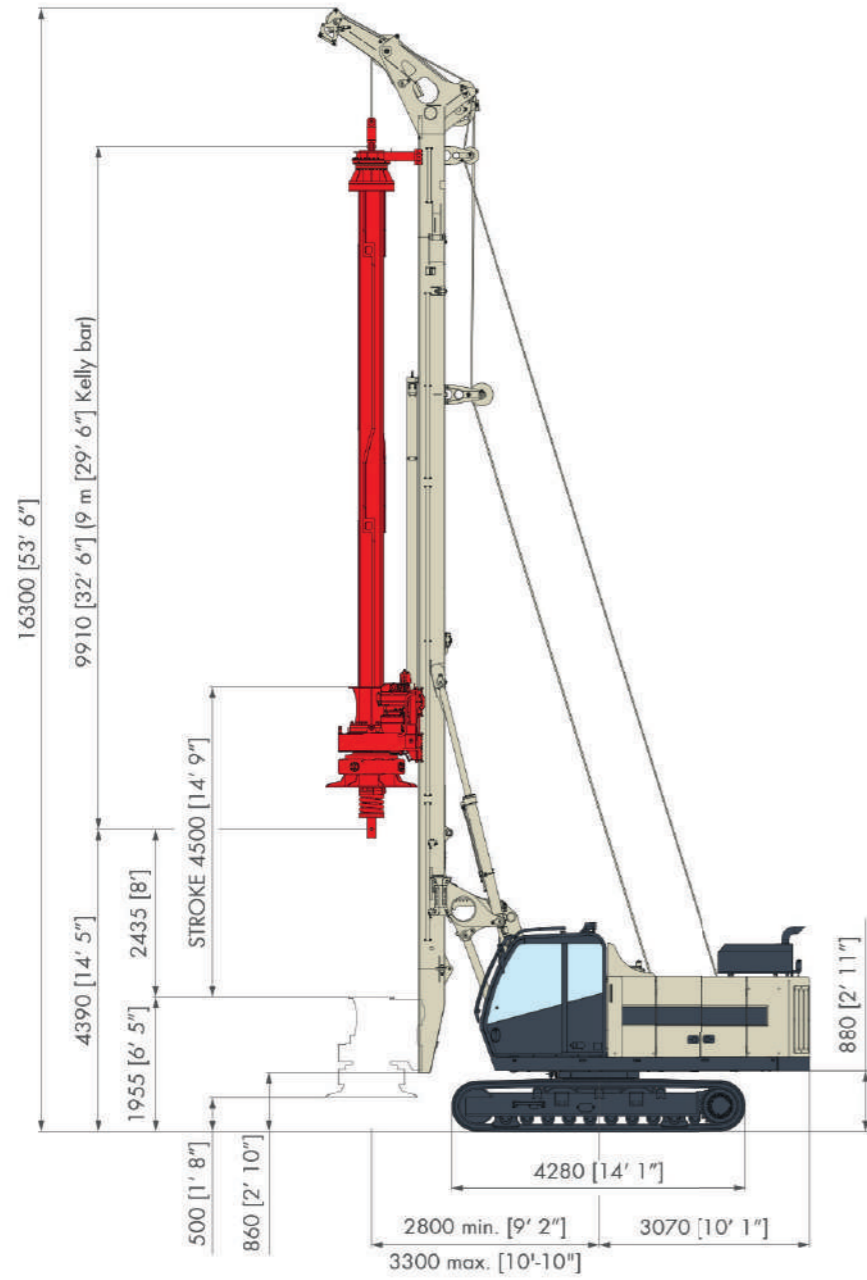

CPD (Cylinder Pull Down)	m.s.	i.s.		
Nominal max. torque	kNm	lb-ft	132 at 35 MPa	97,300 at 5,076 psi
Max. torque	kNm	lb-ft	113 at 30 MPa	83,300 at 4,350 psi
Engine power rating	kW	hp	123 -142 at 2000 rpm	165 - 190 at 2000 rpm
Max. pile diameter	mm	ft-in	1.300¹ / 1.500²	4' 3" ¹ / 4' 11" ²
Max. pile depth	mm	ft-in	48.500³	159' 1" ³
Operating weight w/o tool	kg	lbs	29.850⁴	65,800 ⁴

NOTES	(1) Tool in front of mast	(3) Using 5 elements kelly bar
	(2) Tool below mast	(4) c/w 4 x 9 m (4 x 29'6") long 355 mm (14") dia. Kelly bar; rotary c/w bucket opening flange

CH 320

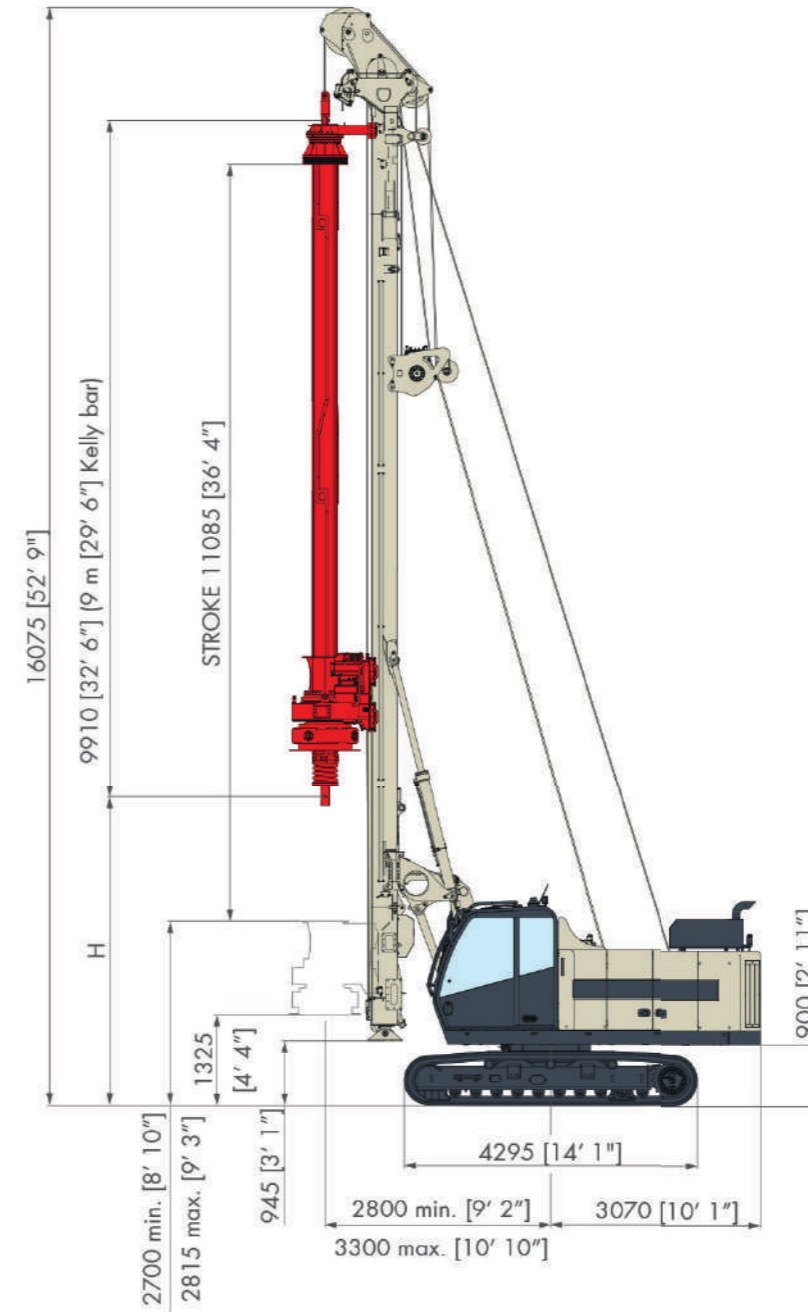

WPD (Winch Pull Down)	m.s.	i.s.		
Nominal max. torque	kNm	lb-ft	132 at 35 MPa	97,300 at 5,076 psi
Max. torque	kNm	lb-ft	113 at 30 MPa	83,300 at 4,350 psi
Engine power rating	kW	hp	123 -142 at 2000 rpm	165 - 190 at 2000 rpm
Max. pile diameter	mm	ft-in	1.180¹ / 1.500²	3' 10" ¹ / 4' 11" ²
Max. pile depth	mm	ft-in	47.500³	155' 10" ³
Operating weight w/o tool	kg	lbs	31.600⁴	70,000 ⁴

NOTES	(1) Tool in front of mast	(3) Using self mounting 5 elements kelly bar
	(2) Tool below mast	(4) c/w 4 x 9 m (4 x 29'6") long 355 mm (14") dia. Kelly bar; rotary c/w bucket opening flange

CH 450

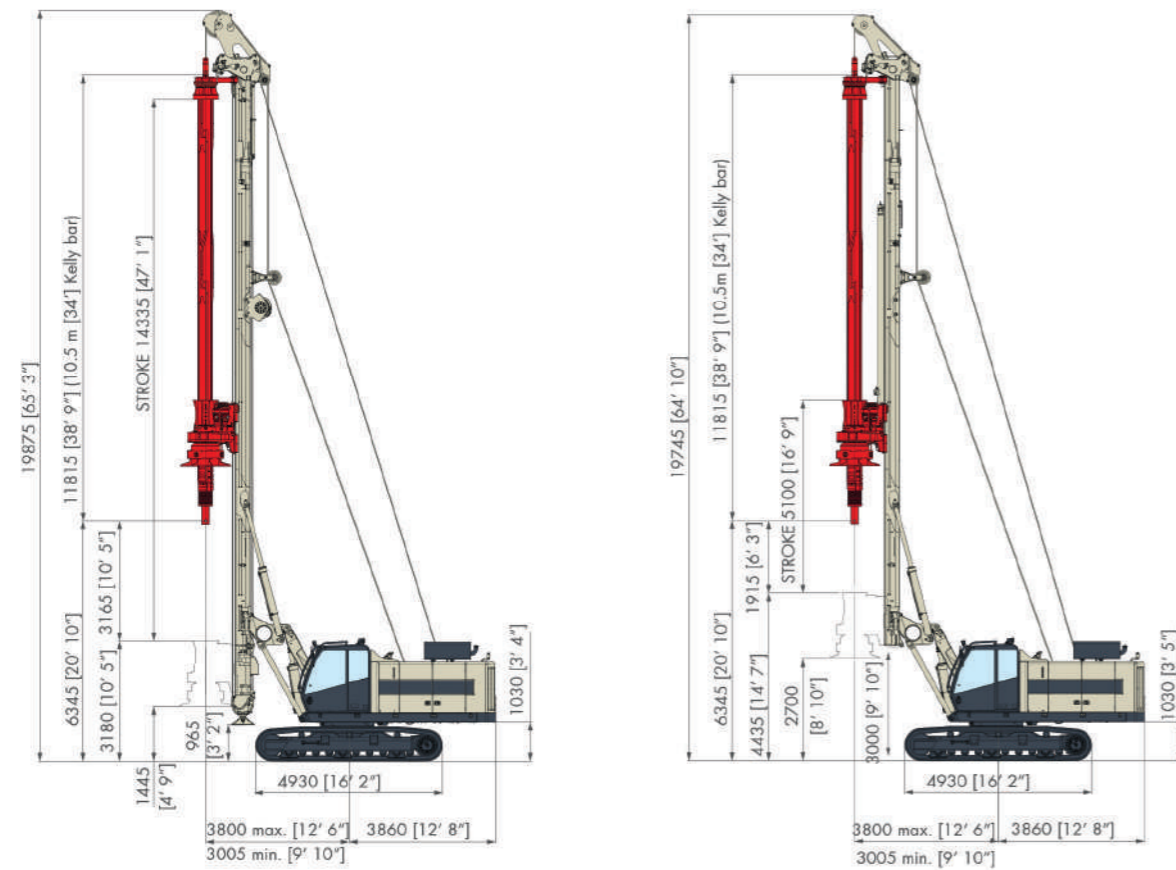

	WPD (Winch Pull Down)		m.s.	i.s.	CPD (Cylinder Pull Down)	
Nominal max. torque	190 at 33 MPa	140,000 at 4,800 psi	kNm	lbf-ft	190 at 33 MPa	140,000 at 4,800 psi
Max. torque	165 at 28,5 MPa	121,700 at 4,130 psi	kNm	lbf-ft	165 at 28,5 MPa	121,700 at 4,130 psi
Engine power rating	201 - 209 at 2000 rpm	274 - 284 at 2000 rpm	kW	hp	201 - 209 at 2000 rpm	274 - 284 at 2000 rpm
Max. pile diameter	1.300 / 2.000¹	4' 3" - 6' 7" ¹	mm	ft-in	1.500⁴ / 1.800⁴ - 2.000⁵	4' 11" ⁴ / 5' 11" ⁴ - 6' 7" ⁵
Max. pile depth	62.900²	206' 4" ²	mm	ft-in	56.600²	185' 8" ²
Operating weight w/o tool	44.800³	98,800 ³	kg	lbs	43.100³	95,000 ³

NOTES	(1) With - without bottom mast element	(3) c/w 4 x 9 m (4 x 29'6") long 368 mm (14" 1/2) dia. Kelly bar; rotary c/w bucket opening flange
	(2) Using self mounting kelly bar	(4) Tool in front of mast
		(5) Tool below mast

CH 650

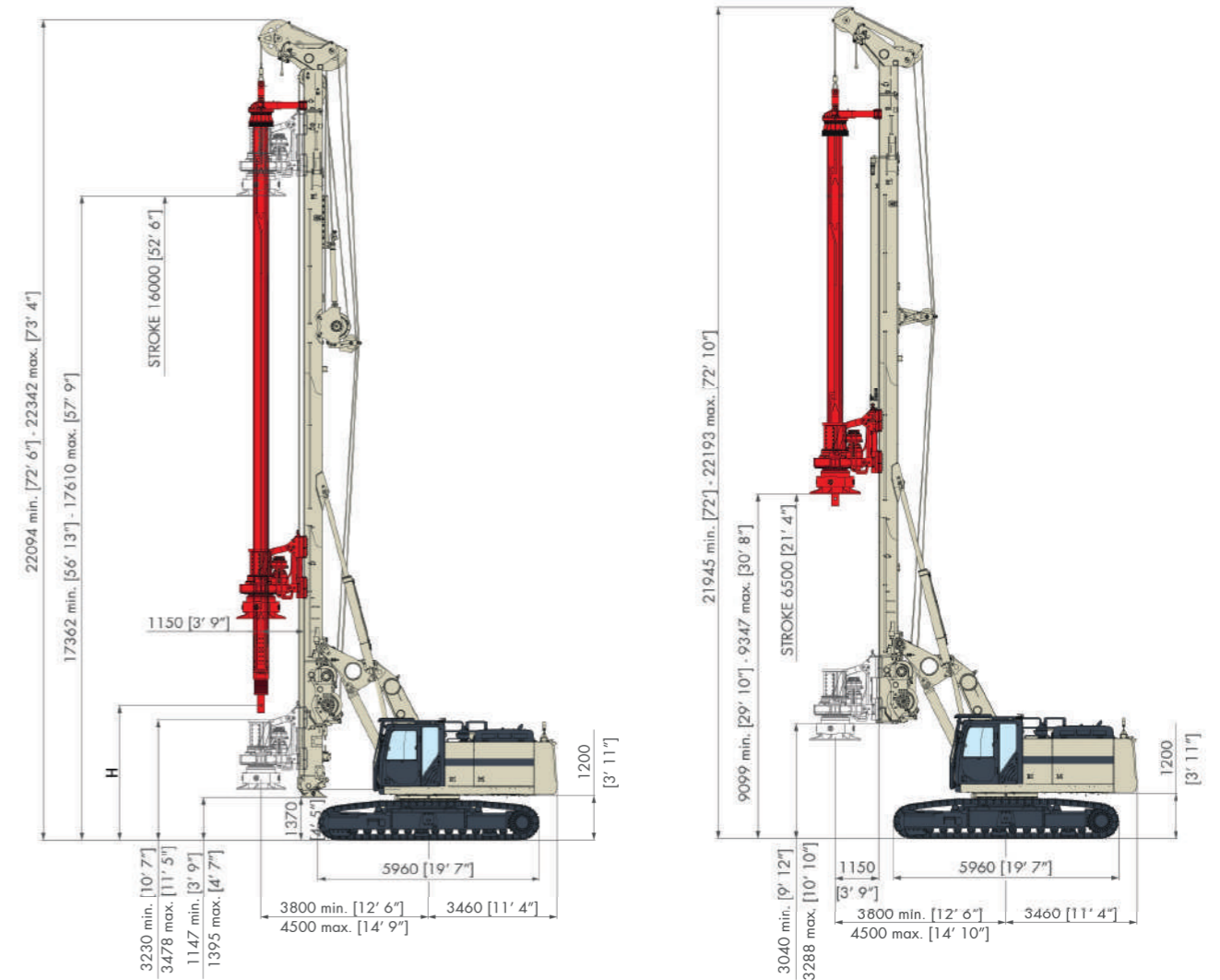
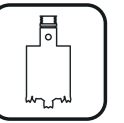

	WPD (Winch Pull Down)		m.s.	i.s.	CPD (Cylinder Pull Down)	
Nominal max. torque	262 at 35 MPa	93,200 at 5,080 psi	kNm	lbf-ft	262 at 35 MPa	93,200 at 5,080 psi
Max. torque	225 at 30 MPa	166,000 at 4,350 psi	kNm	lbf-ft	225 at 30 MPa	166,000 at 4,350 psi
Engine power rating	234 -261 at 2000 rpm	314 - 350 at 2000 rpm	kW	hp	234 -261 at 2000 rpm	314 - 350 at 2000 rpm
Max. pile diameter	2.000 / 2.500¹	6' 7" - 8' 2" ¹	mm	ft-in	2.000 / 2.500¹	6' 7" / 8' 2" ¹
Max. pile depth	69.000²	226' 4" ²	mm	ft-in	68.000^{2/4}	223' 1" ^{2/4}
Operating weight w/o tool	71.600³	159,100 ³	kg	lbs	69.900⁵	155,300 ⁵

NOTES	(1) With - without bottom mast element	(3) c/w kelly bar 4 x 10,5 m (4 x 34' 5") Ø 406 (1' 4") and bucket opening flange
	(2) Using self mounting kelly bar	(4) With mast foot installed
		(5) c/w kelly bar 4 x 10,5 m (4 x 34' 5") Ø 406 (1' 4") and bucket opening flange; w/o bottom mast element

CFA

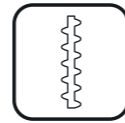

CH 150

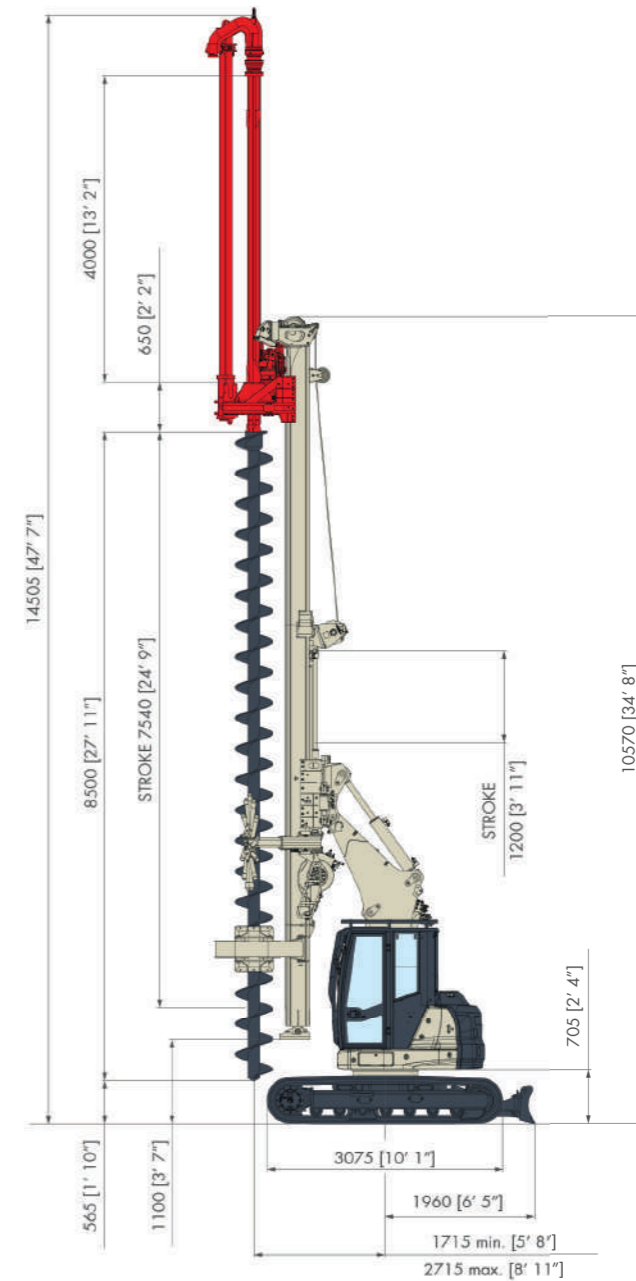
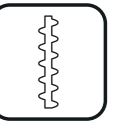

CFA (Continuous Flight Auger)	m.s.	i. s.		
Nominal max. torque	kNm	lb-ft	44 at 35 MPa	32,450 at 5,076 psi
Max. torque	kNm	lb-ft	35 at 28 MPa	166,000 at 4,350 psi
Engine power rating	kW	hp	54 at 2100 rpm	73 at 2100 rpm
Max. pile diameter	mm	ft-in	750	2' 6"
Max. length of augers	mm	ft-in	8.500	27' 11"
Max. pile depth	mm	ft-in	8.100 + 4.000 = 12.100¹	26' 7" + 13' 1" = 39' 8"
Extraction force	kN	lbs	170	37,217
Crowd force on auger	kN	lbs	60	13,500
Operating weight w/o tool	kg	lbs	13.000	28,700

NOTE | (1) With 4,0 m (13' 1") auger extension & star cleaner

CH 300

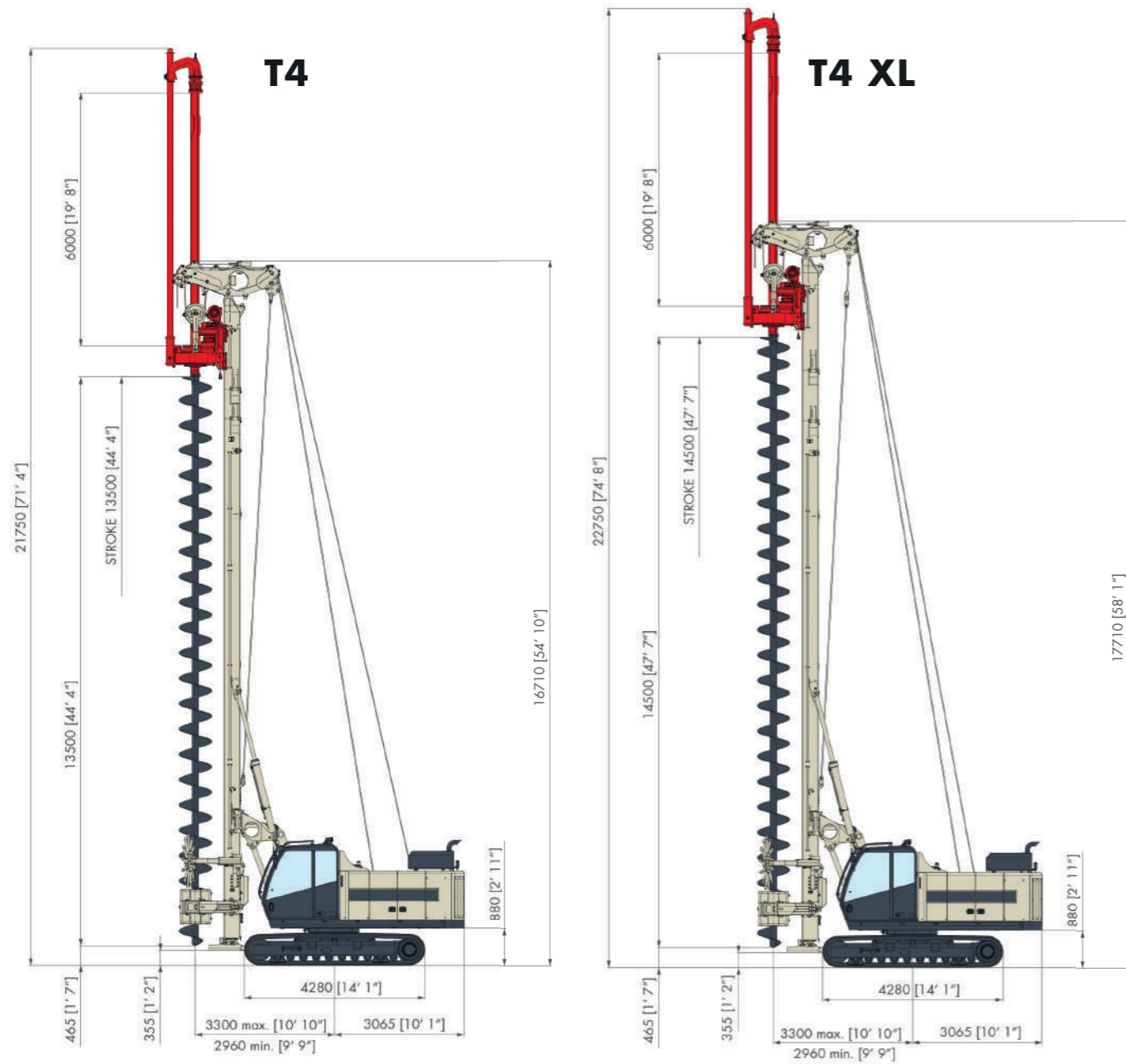
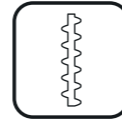

CFA (Continuous Flight Auger)	T4	m.s.	i.s.	T4 XL	Quick Conversion
Nominal max. torque	132 at 35 MPa	97,300 at 5,076 psi	kNm lbf-ft	132 at 35 MPa	97,300 at 5,076 psi
Max. torque	113 at 30 MPa	83,300 at 4,350 psi	kNm lbf-ft	113 at 30 MPa	83,300 at 4,350 psi
Engine power rating	123-142 at 2000 rpm	165-190 at 2000 rpm	kW hp	123-142 at 2000 rpm	165-190 at 2000 rpm
Max. pile diameter	800	2' 7"	mm ft-in	800	2' 7"
Max. length of augers	13.500	44' 4"	mm ft-in	14.500	47' 6"
Max. pile depth	13.000 + 6.000 = 19.000	42' 8" + 19' 8" = 62' 4"	mm ft-in	14.000 + 6.000 = 20.000	45' 11" + 19' 8" = 65' 7"
Extraction force	320	71,900	kN lbs	320	71,900
Crowd force on auger (optional)	45	10,100	kN lbs	45	10,100
Operating weight w/o tool	29.550¹	65,150 ¹	kg lbs	29.000¹	64,000 ¹

NOTE (1) With 6 m (19' 8") auger extension, additional counterweight & star cleaner; without pull down winch on rotary

CH 320

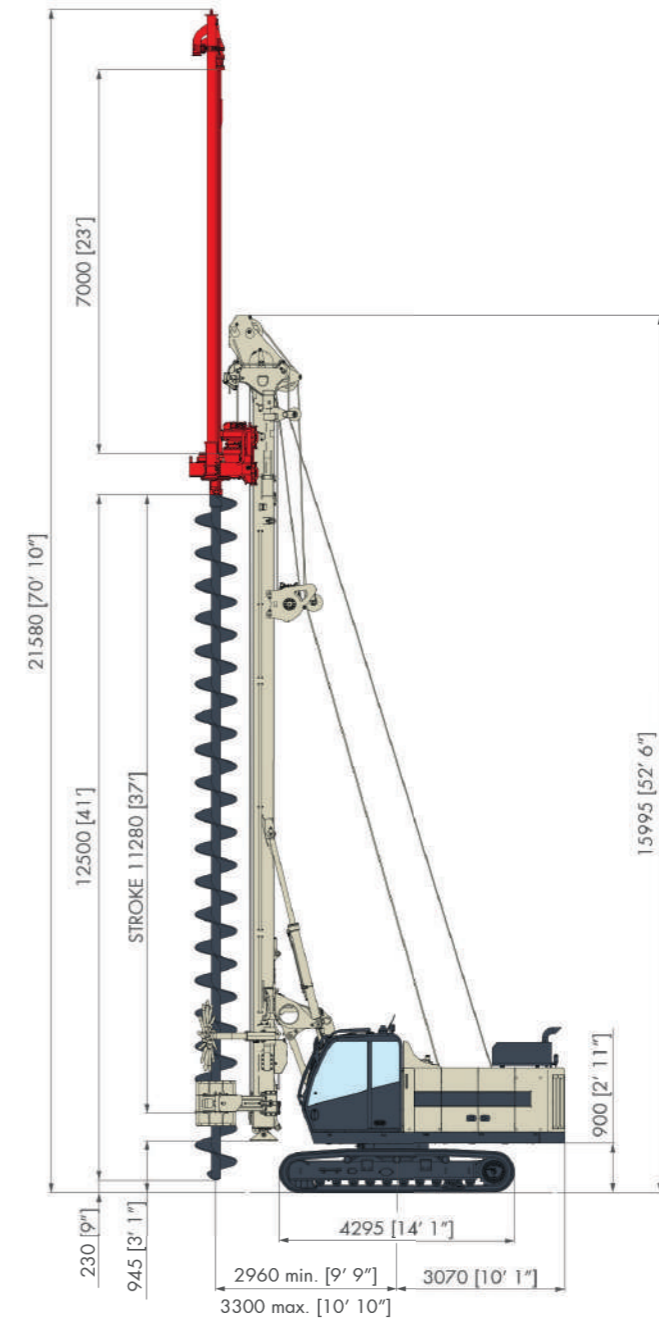
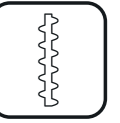

CFA (Continuous Flight Auger)	m.s.	i.s.	Quick Conversion
Nominal max. torque	kNm lbf-ft		132 at 35 MPa 97,300 at 5,076 psi
Max. torque	kNm lbf-ft		113 at 30 MPa 83,300 at 4,350 psi
Engine power rating	kW hp		123 - 142 at 2000 rpm 165 - 190 at 2000 rpm
Max. pile diameter	mm ft-in		800 2' 7"
Max. length of augers	mm ft-in		12.500 41'
Max. pile depth	mm ft-in		11.000 + 7.000 = 18.000 36' 1" + 23' = 59' 1"
Extraction force	kN lbs		250 56,200
Crowd force on auger (optional)	kN lbs		100 22,500
Operating weight w/o tool	kg lbs		27.200¹ 60,000 ¹

NOTE (1) With 7 m (23') auger extension & star cleaner; without pull down winch on rotary

CH 450

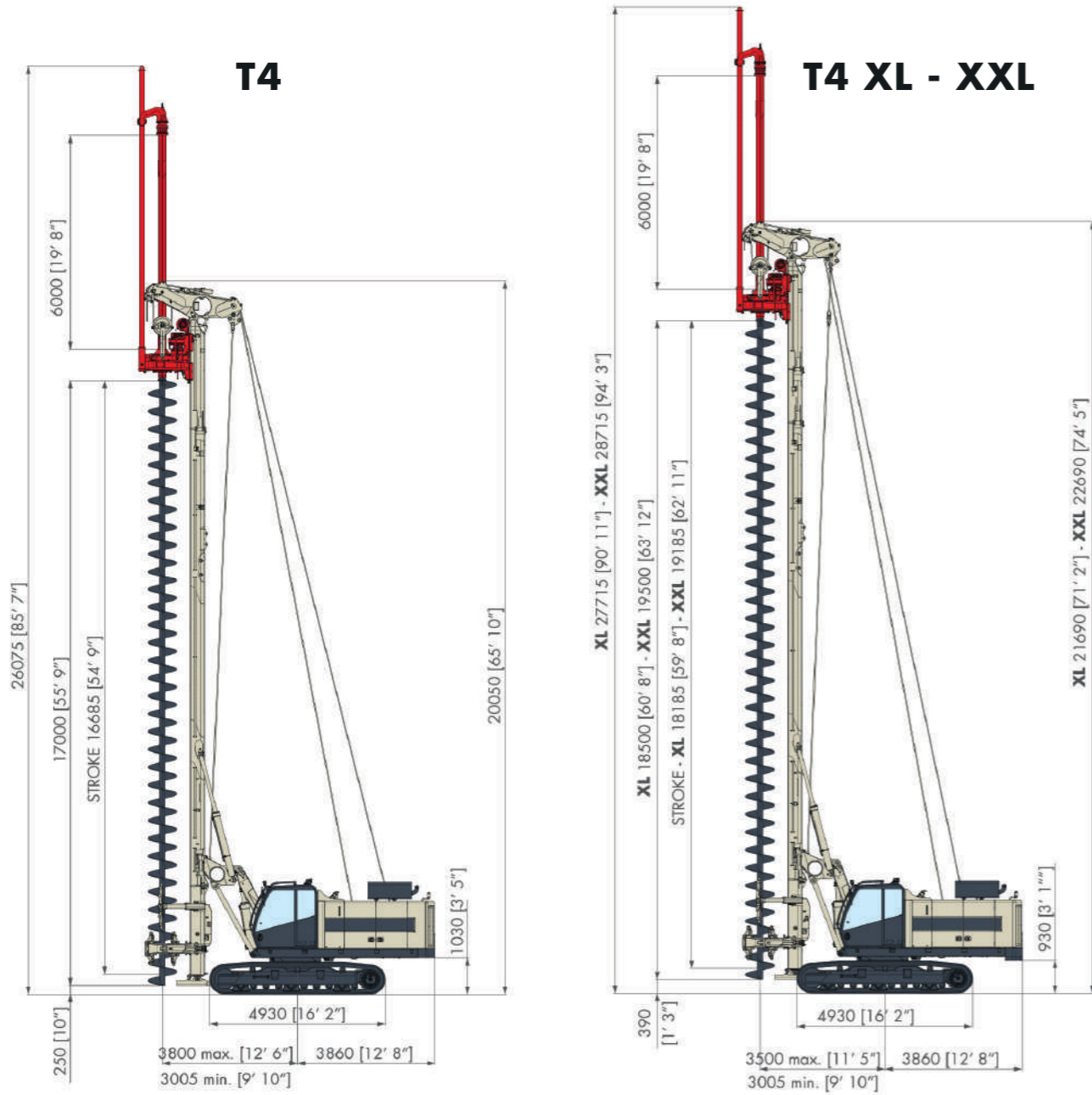
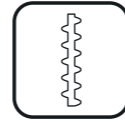

CFA (Continuous Flight Auger)	m.s.	i.s.	T4		T4 XL		T4 XXL	
Nominal max. torque	kNm	lb-ft	190 at 33 MPa		140,000 at 4,800 psi			
Max. torque	kNm	lb-ft	165 at 28,5 MPa		121,700 at 4,130 psi			
Engine power rating	kW	hp	201 - 209 at 2000 rpm		274 - 284 at 2000 rpm			
Max. pile diameter	mm	ft-in	1.000	3' 3"	1.000	3' 3"	1.000	3' 3"
Max. length of augers	mm	ft-in	17.000	55' 9"	18.500	60' 8"	19.500	63' 11"
Max. pile depth	mm	ft-in	16.500 + 6.000 = 22.500	54' 2" + 19' 8" = 73' 10"	18.000 + 6.000 = 24.000	59' 1" + 19' 8" = 78' 9"	19.000 + 6.000 = 25.000	62' 4" + 19' 8" = 81' 12"
Extraction force	kN	lbs	480	107,900	480	107,900	480	107,900
Crowd force on auger (optional)	kN	lbs	45	10,200	45	10,200	45	10,200
Operating weight w/o tool	kg	lbs	42.500	93,700	43.500	95,900	43.700	96,300

CHF 500

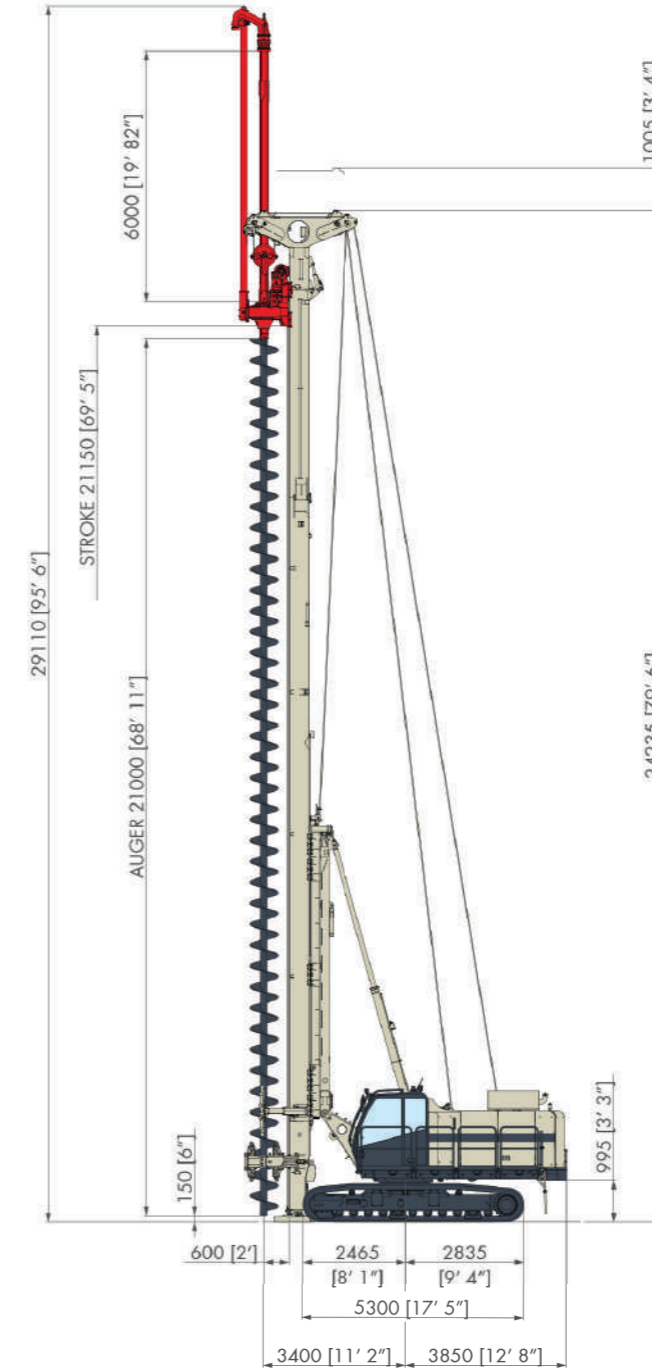
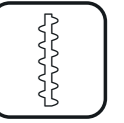

CFA (Continuous Flight Auger)	m.s.	i.s.		
Nominal max. torque	kNm	lb-ft	184 at 35 MPa	135,700 at 5,080 psi
Max. torque	kNm	lb-ft	152 at 29 MPa	112,000 at 4,200 psi
Engine power rating	kW	hp	201 - 231 at 2000 rpm	270 - 310 at 2000 rpm
Max. pile diameter	mm	ft-in	1.000	3' 3"
Max. length of augers	mm	ft-in	21.000	69'
Max. pile depth	mm	ft-in	21.000 + 6.000 = 27.000	69' + 19' 8" = 89'
Extraction force	kN	lbs	540	121,400
Crowd force on auger (optional)	kN	lbs	45	10,120
Operating weight w/o tool	kg	lbs	46.000	101,420

CH 650

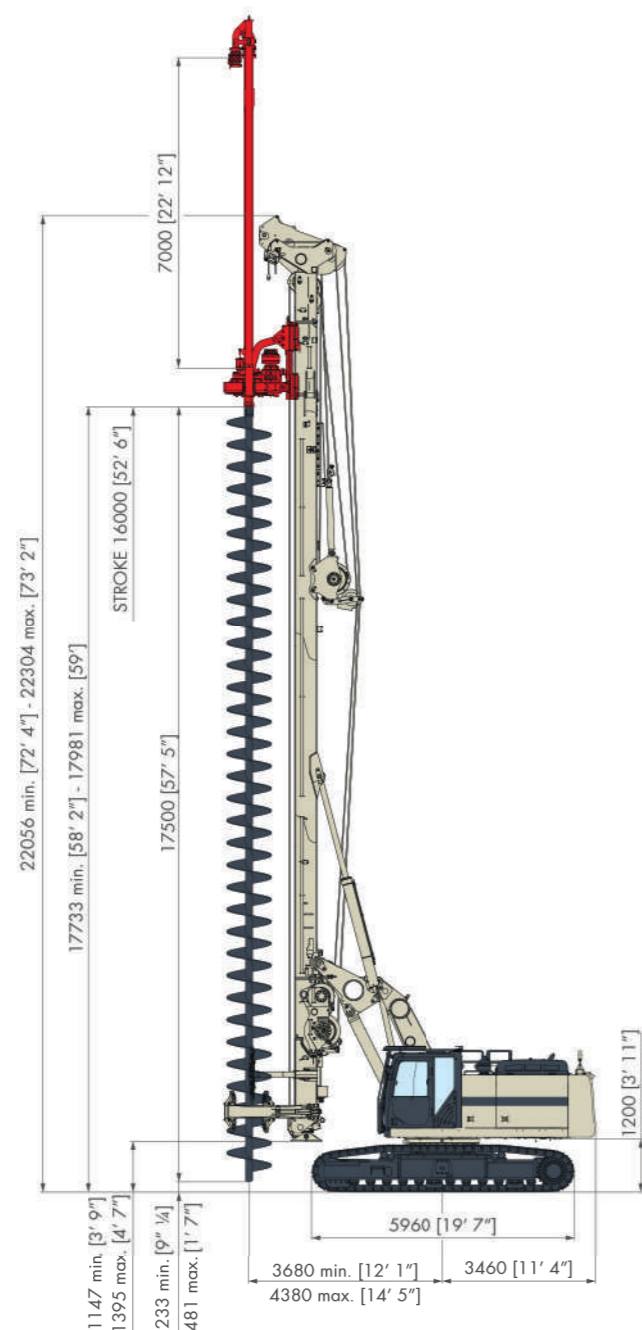
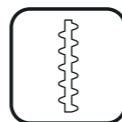

CFA (Continuous Flight Auger)	m.s.	i.s.	Quick Conversion	
Nominal max. torque	kNm	lb-ft	262 at 35 MPa	93,200 at 5,080 psi
Max. torque	kNm	lb-ft	225 at 30 MPa	166,000 at 4,350 psi
Engine power rating	kW	hp	234 - 261 at 2000 rpm	314 - 350 at 2000 rpm
Max. pile diameter	mm	ft-in	1.000	3' 3"
Max. length of augers	mm	ft-in	17.500	57' 5"
Max. pile depth	mm	ft-in	15.500 + 7.000 = 22.500	50' 10" + 22' 1" = 73' 9"
Extraction force	kN	lbs	580 - 700^{Optional}	130,400 - 157,400 ^{Optional}
Crowd force on auger (optional)	kN	lbs	140	31,500
Operating weight w/o tool	kg	lbs	65.650¹	143,300 ¹

NOTE | (1) With auger extension, auger cleaner, swivel and swan neck

CHF 900

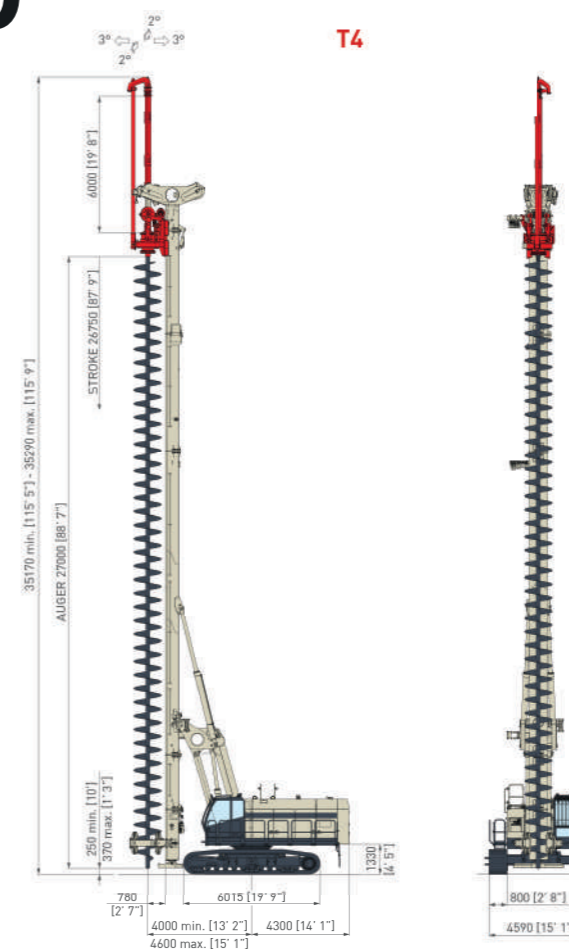
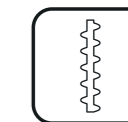

CFA (Continuous Flight Auger)	m.s.	i.s.	Quick Conversion	
Nominal max. torque	kNm	lb-ft	280 at 35 MPa	206,500 at 5,080 psi
Max. torque	kNm	lb-ft	256 at 32 MPa	188,800 at 4,640 psi
Engine power rating	kW	hp	345 - 405 at 1700 rpm	462 - 543 at 1700 rpm
Max. pile diameter	mm	ft-in	1.200	3' 11"
Max. length of augers	mm	ft-in	27.000	88' 7"
Max. pile depth	mm	ft-in	26.500 + 6.000 = 32.500	87' + 19' 8" = 106' 82"
Extraction force	kN	lbs	1.120	251,800
Crowd force on auger (optional)	kN	lbs	150	33,700
Operating weight w/o tool	kg	lbs	86.100¹	189,800 ¹

NOTE | (1) c/w 6 m auger extension, bottom opening gate and star type auger cleaner

DP/SM

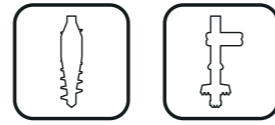

CH 320

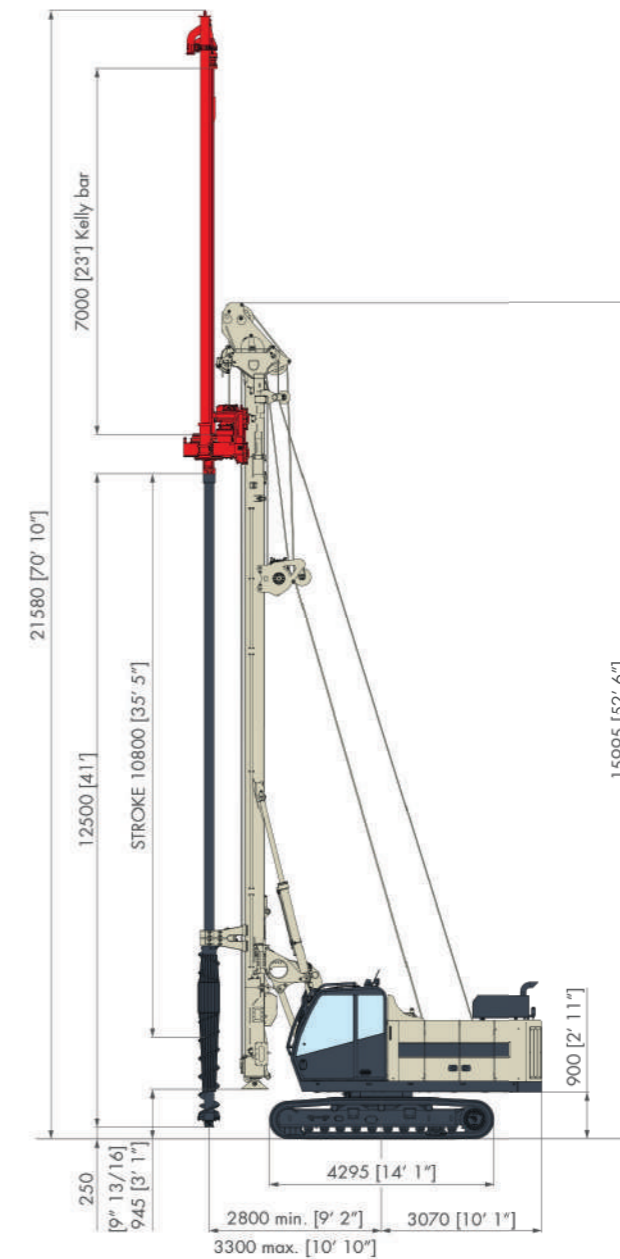

DP (Displacement Piles) SM (Soil Mixing)	m.s.	i.s.		
Nominal max. torque	kNm	lbf-ft	132 at 35 MPa	97,300 at 5,076 psi
Max. torque	kNm	lbf-ft	113 at 30 MPa	83,300 at 4,350 psi
Engine power rating	kW	hp	123 - 142 at 2000 rpm	165 - 190 at 2000 rpm
Max. drill string length	mm	ft-in	12.500	41'
Max. length of drill string extension	mm	ft-in	7.000	23'
Max. pile depth	mm	ft-in	10.500 + 7.000 = 17.500	34' 5" + 23' = 57' 5"
Extraction force	kN	lbs	250	56,200
Max. pull down force	kN	lbs	160	36,000
Operating weight w/o tool	kg	lbs	27.000	59,500

CH 450

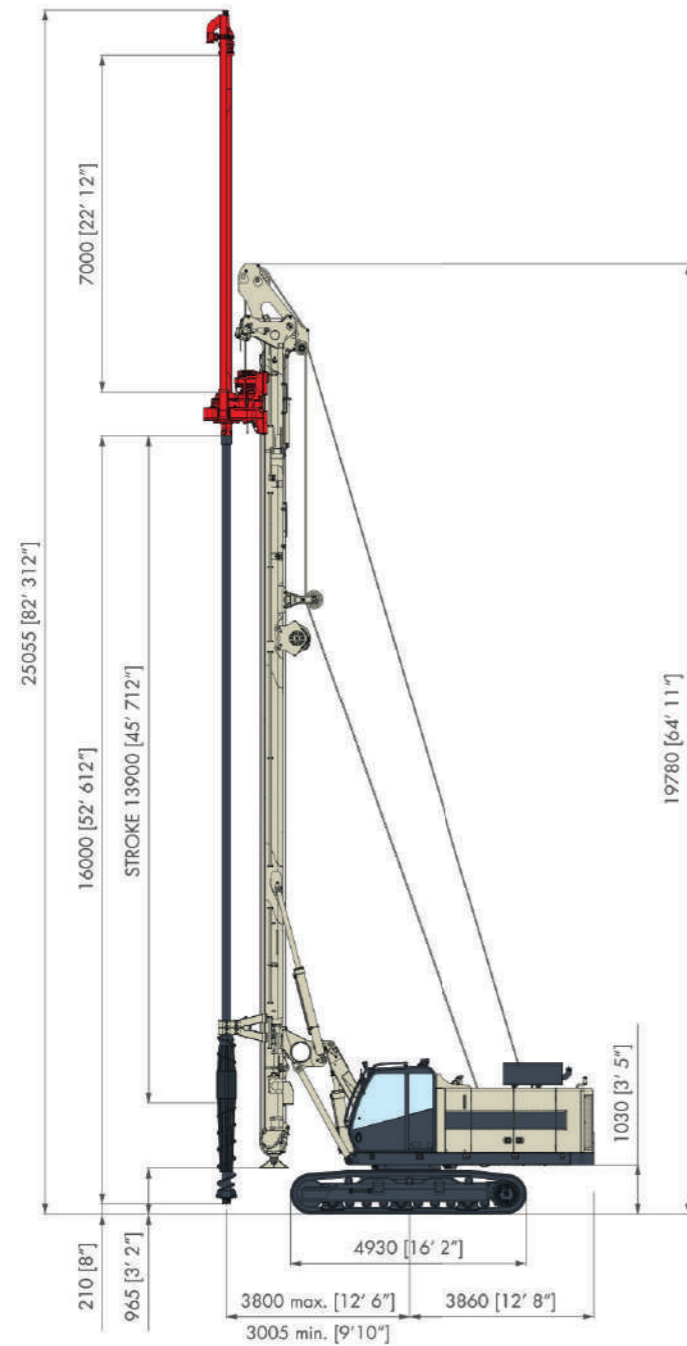
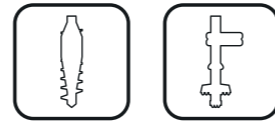

DP (Displacement Piles) SM (Soil Mixing)	m.s.	i.s.		
Nominal max. torque	kNm	lbf-ft	190 at 33 MPa	140,000 at 4,800 psi
Max. torque	kNm	lbf-ft	165 at 28,5 MPa	121,700 at 4,130 psi
Engine power rating	kW	hp	201 - 209 at 2000 rpm	274 - 284 at 2000 rpm
Max. drill string length	mm	ft-in	16.000	52' 6"
Max. length of drill string extension	mm	ft-in	8.500	27' 11"
Max. pile depth	mm	ft-in	13.500 + 8.500 = 22.000	44' 3" + 27' 11" = 72' 2"
Extraction force	kN	lbs	330	74,200
Max. pull down force	kN	lbs	240	53,954
Operating weight w/o tool	kg	lbs	41.500	91,500

CH 650

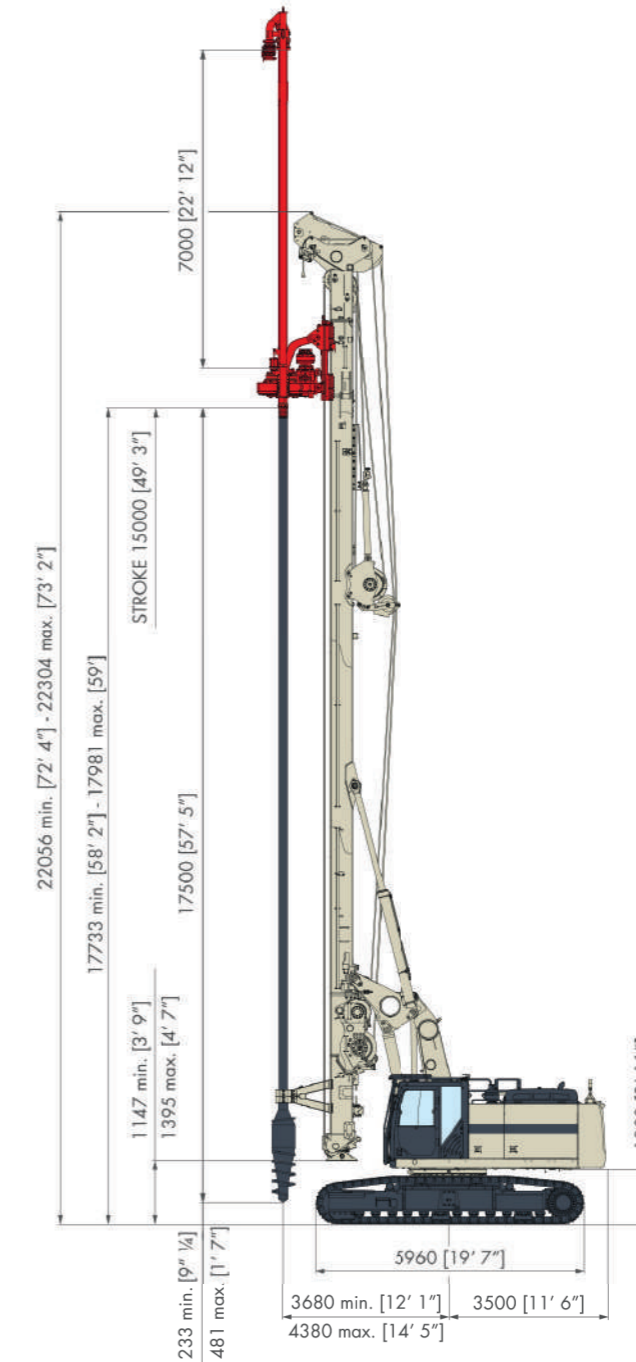

DP (Displacement Piles) SM (Soil Mixing)	m.s.	i.s.		
Nominal max. torque	kNm	lbf-ft	262 at 35 MPa	93,200 at 5,080 psi
Max. torque	kNm	lbf-ft	225 at 30 MPa	166,000 at 4,350 psi
Engine power rating	kW	hp	234 - 261 at 2000 rpm	314 - 350 at 2000 rpm
Max. drill string length	mm	ft-in	17.500	57' 5"
Max. length of drill string extension	mm	ft-in	7.000	22' 11"
Max. pile depth	mm	ft-in	14.500 + 7.000 = 21.500	47' 7" + 22' 11" = 70' 6"
Extraction force	kN	lbs	580 - 700 Optional	130,400 - 157,400 Optional
Max. pull down force	kN	lbs	140	31,500
Operating weight w/o tool	kg	lbs	60.000	133,400

LDTH

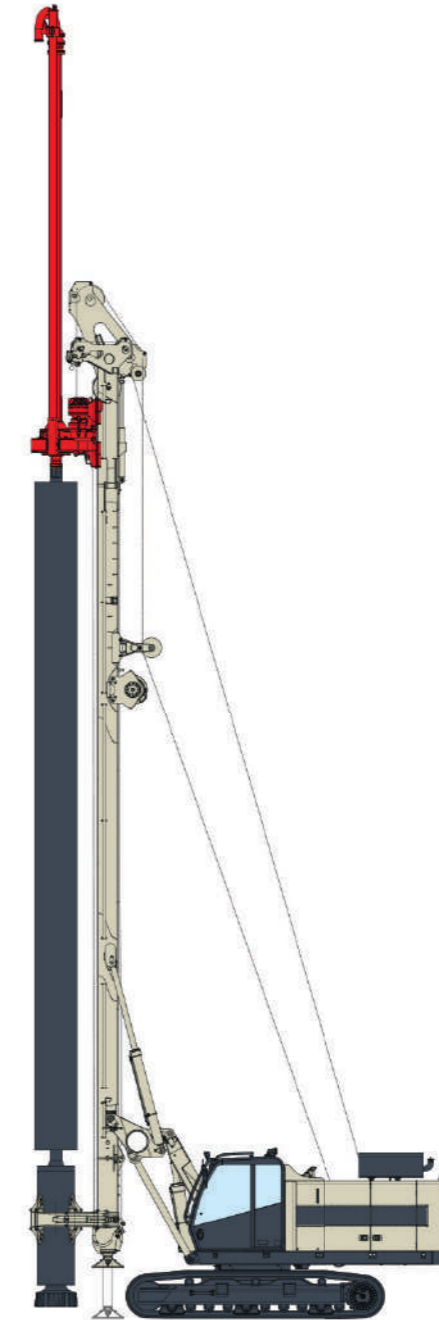

LDTH (Large DTH)	m.s.	i.s.	CH 320		CH 450		CH 650	
Max. pile diameter	mm	ft-in	800	2' 8"	1.000	3' 3"	1.000	3' 3"
Stroke c/w mast foot	mm	ft-in	11.200	36' 8"	14.500	47' 7"	16.000	52' 5"
Max. pile depth	mm	ft-in	Approx. 40.000 - 50.000¹	Approx. 131' 2" - 165" ¹	Approx. 50.000 - 60.000¹	Approx. 164' - 196' ¹	Approx. 60.000 - 70.000¹	Approx. 196' - 229' 7" ¹
Extraction force	kN	lbs	250	56,200	330	74,200	580	130,400
Operating weight w/o tool	kg	lbs	27.200	60,000	41.500	91,500	65.650	144,700

NOTE | (1) Max. depth is upon drill string weight and diameter

MP



CH 450

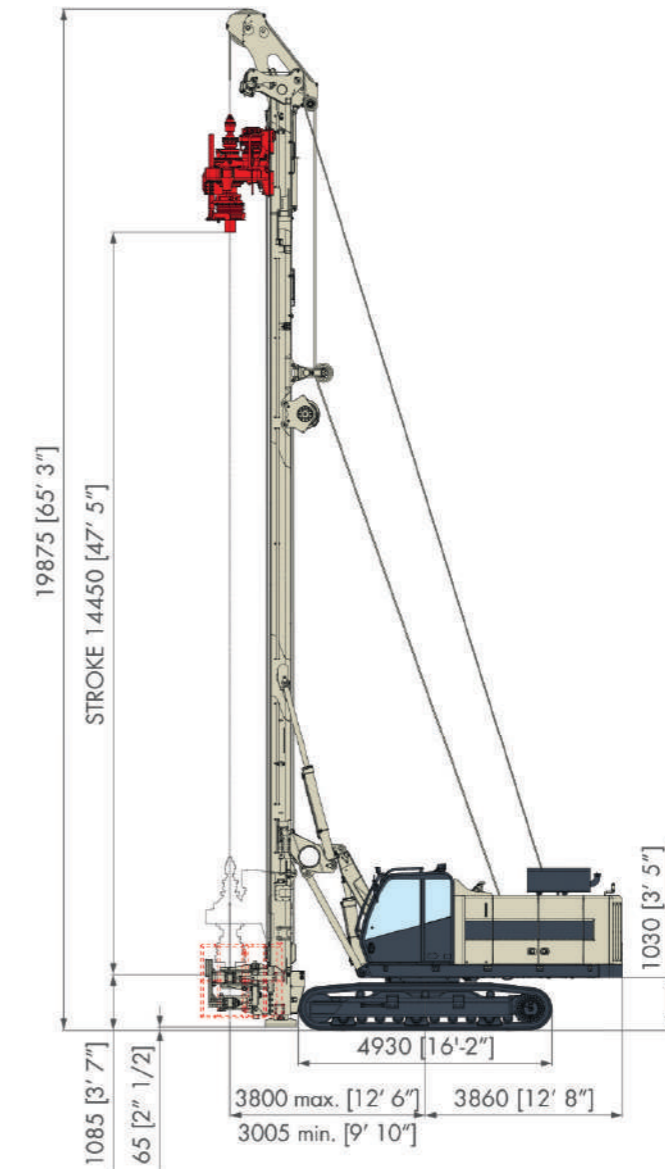

MP (Micropiles)	m.s.	i. s.	DOUBLE HEAD		SINGLE HEAD	
Max. feed force	kN	lbs	93	20,900	240	53,900
Max. retract force	kN	lbs	204	45,800	240	53,900
MAST						
Feed Stroke	mm	ft-in	14.500	47' 6"	14.500	47' 6"
DOUBLE CLAMP WITH CASING EXTRACTOR						
Clamping range	mm	in	120 - 620	4 3/4" - 24"	120 - 620	4 3/4" - 24"
ROTARY HEAD						
			UPPER HEAD		LOWER HEAD	
Gears	-	-	3		4	
Max. torque	kNm	lbs-ft	24.7	18,200	106.2	78,300
Max. speed	rpm	rpm	97		36	
OPERATING WEIGHT W/O TOOL						
	kg	lbs	43.700	96,400	43.400	95,700

NOTE MP Configuration is also available for CH 320 & CH 650 piling rig

NOTES





DEEP FOUNDATIONS & GROUND IMPROVEMENT



Comacchio S.p.A.
Via Callalta, 24/B
31039 Riese Pio X (Tv) Italy
T +39 0423 7585
F + 39 0423 755592
sales@comacchio.com

comacchio.com